

A HANDBOOK FOR  
**Inventors &  
Innovators**

TECHNOLOGY TRANSFER  
AT THE UNIVERSITY  
OF ILLINOIS

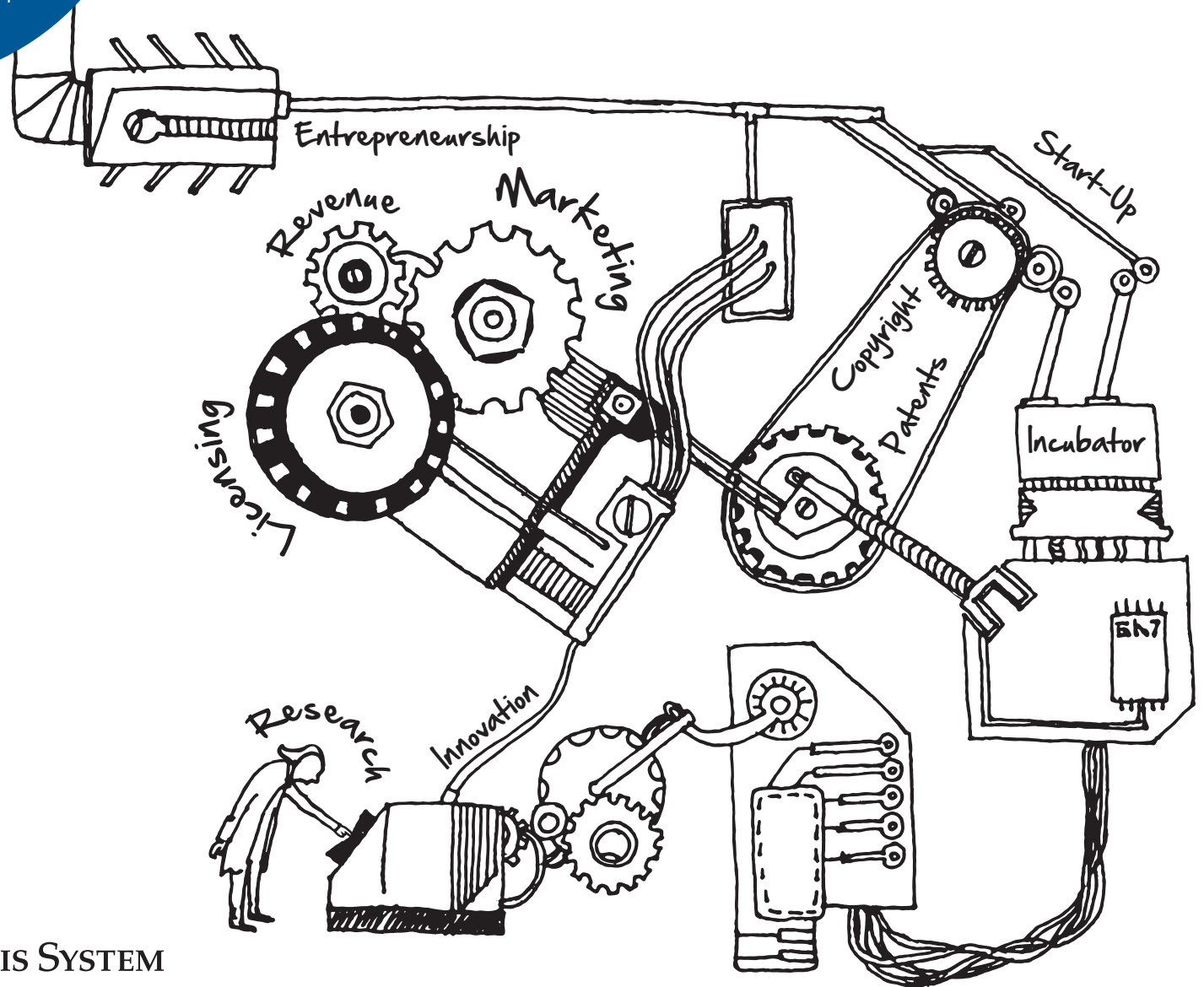



A HANDBOOK FOR

# Inventors & Innovators

TECHNOLOGY TRANSFER AT THE UNIVERSITY OF ILLINOIS



UNIVERSITY OF ILLINOIS SYSTEM

©2013 • THE BOARD OF TRUSTEES OF THE UNIVERSITY OF ILLINOIS  
ALL RIGHTS RESERVED • 5TH PRINTING, FEBRUARY 2017



TABLE OF  
**Contents**

**INTRODUCTION ..... 6**

The University's System for Technology Transfer .....7  
Sponsored Research .....9

**INTELLECTUAL PROPERTY ..... 10**

University Ownership ..... 10  
Student Ownership ..... 11  
Exception to Standard University Ownership Rules for Student  
Entrepreneurial Activities ..... 11

**PATENTS ..... 12**

Inventions & Patents .....12  
Inventorship ..... 12  
Ownership ..... 12  
The Standard Tests of Patentability ..... 12  
Publication and Public Disclosure ..... 13  
What Constitutes a Public Disclosure? ..... 14  
Being First ..... 14  
Patents as Property ..... 14  
Patents & Freedom to Operate ..... 15

Patent Application Process ..... 16  
Patent Decisions .....17  
U.S. Patent Decisions ..... 17  
International and PCT Application Decisions ..... 17  
Foreign Country and Region Specific Patent Decisions ..... 17

**COPYRIGHT & TRADEMARK .....18**

Copyright ..... 18  
Copyright Applies Automatically ..... 18  
Trademarks & Service Marks ..... 19

**THE TECHNOLOGY TRANSFER PROCESS ... 20**

The Office of Technology Management..... 20  
Intellectual Property Disclosures/Reports  
of Research Discoveries ..... 20  
Screening Evaluation/Assessment ..... 20  
Patenting Decisions ..... 21  
Market Assessment ..... 21  
Release License or Assign to Inventor ..... 21  
Marketing (Seeking Partners) .....22

Marketing Related Agreements (Pre-Licensing) .....	23
Licensing .....	24
License Compliance .....	24
License Negotiations .....	24
Revenue Sharing .....	25
Other Methods of Innovation Transfer .....	25
Academic and Research Use, Creative Commons Licensing, and Open Source Licensing .....	26
Mobile Apps .....	26

## CONSULTING & INTELLECTUAL PROPERTY ..... 27

Faculty Consulting and the University .....	27
Scope of Work .....	27
Intellectual Property .....	27
Confidentiality .....	27
Exclusivity .....	27
Liability and Indemnification .....	27

## STARTING A COMPANY ..... 28

Start-Up Company Formation Guide and Checklist.....	29
IllinoisVENTURES .....	31
Research Parks and Incubator Facilities .....	32
University of Illinois Research Park & EnterpriseWorks .....	32
EnterpriseWorks Chicago .....	33
Health, Technology, Innovation (HTI) .....	34
SBIR/STTR Program.....	35

## STUDENT ENTREPRENEURSHIP ..... 37

Student Entrepreneur Programs.....	37
------------------------------------	----

## CONTACT ..... 40

# Introduction

With an annual funded research budget of close to \$750 million dollars, the University of Illinois is a leader in generating innovations that translate into products and services that have a profound impact on human lives. These advances have come from all corners of the University, and their impact has created businesses, jobs, and economic well-being.

This handbook is an easy-to-use guide to fundamental information about intellectual property (IP), the University's IP policies and practices, the resources available for technology transfer, and most importantly, your role in the process of commercializing University innovations.



# The University's System for Technology Transfer

The University manages a number of resources designed to facilitate all stages of the process of technology transfer. Overseen by the Office of the Vice President for Research, the University's technology commercialization infrastructure is comprised of the following entities:

- **The Offices of Technology Management (OTMs)** The Chicago and Urbana campuses each have an OTM that evaluates, patents and licenses the University's intellectual property.
- **IllinoisVENTURES LLC** provides consultative services, potential funding, and business development support for early-stage, research-driven companies, particularly those deriving from the University of Illinois, other midwestern universities, and federal laboratories.
- University-associated **research parks and incubators** in Chicago and Urbana support and nurture the growth of early-stage companies. They encourage R&D collaboration between the University and partners in industry and government, as well as attract established companies that benefit from close working relationships with University faculty and students.

## UI's Seamless System of Resources

Research > Innovation > Commercialization

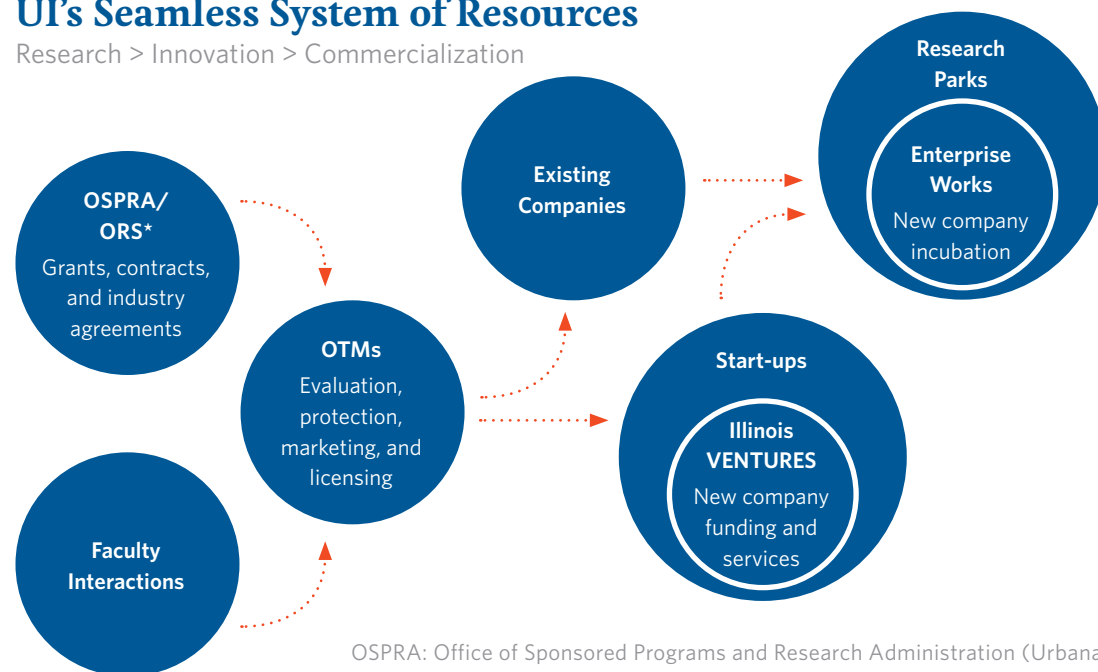

OSPRA: Office of Sponsored Programs and Research Administration (Urbana);  
ORS: Office of Research Services (Chicago)

## Defining Technology Transfer

In its broadest sense, technology transfer is the transfer of knowledge, ideas, discoveries and innovations to the public. There are many ways to accomplish this, including publication, student graduation and employment, participation in scientific meetings, and collaboration with industry and licensing innovations.

For the purposes of this handbook, technology transfer is the evaluation, protection, marketing and licensing of intellectual property to start-ups and existing companies. Additionally, while we use the terms technology and intellectual property interchangeably, there are subtle differences between them. Technology is a subset of intellectual property and commonly refers to commercially useful intellectual property.

## The Bayh-Dole Act

The Bayh-Dole Act, adopted in 1980, was established to promote economic development by allowing small businesses and non-profit organizations (including universities) to own inventions made under federally-funded research programs. Under the Act, universities are:

- Responsible for the management of inventions in compliance with the terms of the Bayh-Dole Act
- Expected to file patent applications on inventions they elect to own
- Encouraged to collaborate with commercial concerns through licensing, to promote the utilization of inventions arising from federal funding
- Expected to give licensing preference to small businesses

The Bayh-Dole Act sets the stage for university participation in technology transfer activities. The government retains certain rights which include requiring use of licensed inventions to prevent sequestering, requiring U.S. manufacture for exclusive licenses, and retaining non-exclusive rights for government purposes.

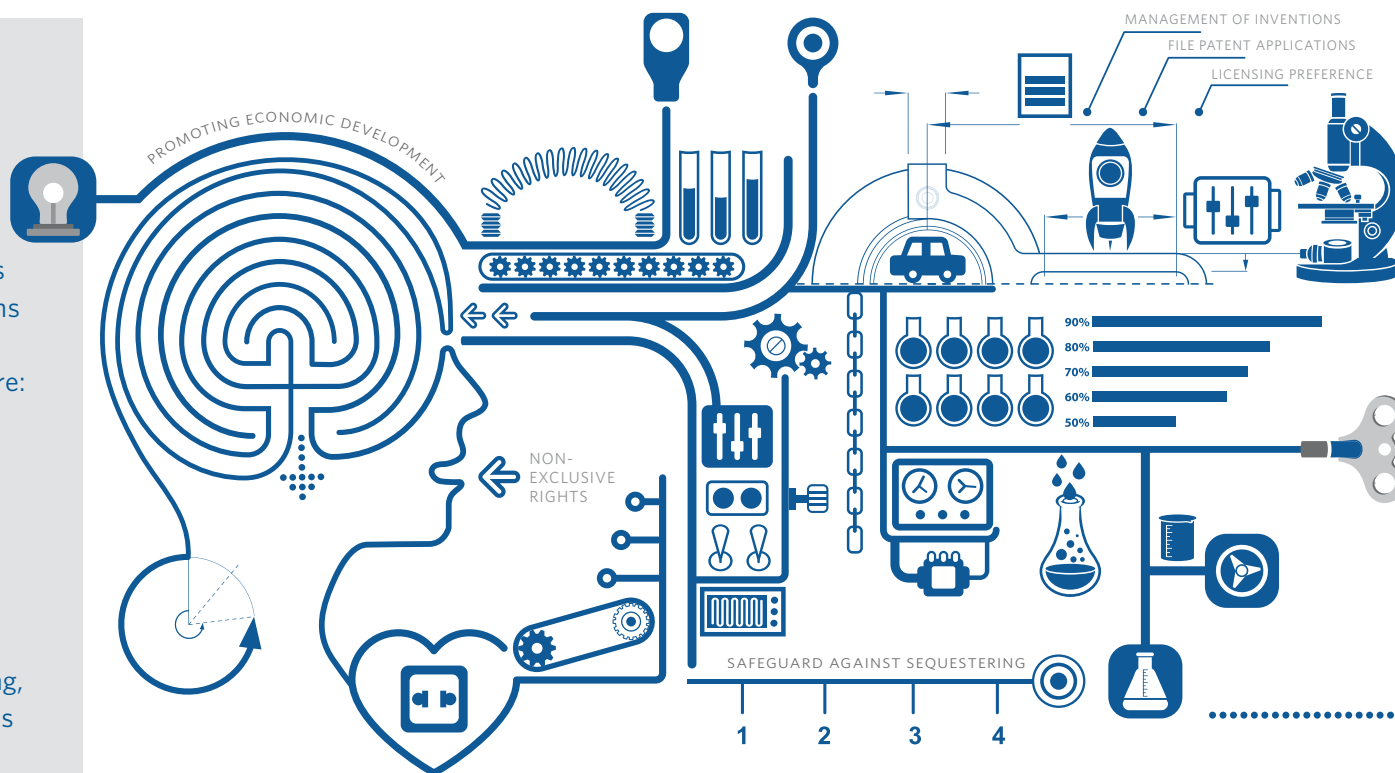

## Benefits of Technology Transfer

- **Leverages** the University's technologies to benefit society
- **Strengthens** the University's education and research programs
- **Assists** in recruiting and retaining faculty, staff, and students
- **Supports** the growth and development of the Illinois and U.S. economies
- **Builds** enduring connections between the University, industry, and public agencies



# Sponsored Research

The work of the Office of Research Services (ORS) on the Chicago campus and the Office of Sponsored Programs and Research Administration (OSPRA) on the Urbana campus is often the first step in the technology transfer process, since they are responsible for University research agreements involving government and corporate sponsors.

Externally sponsored agreements often define the role of the sponsor in the commercialization process. ORS and OSPRA review the intellectual property terms in such agreements to ensure the interests of the University and the researcher are addressed. They consult with the OTMs when such agreements involve existing intellectual property being managed by the OTMs or when the intellectual property terms of the agreements are non-standard.

Because the OTMs and ORS/OSPRA work closely together, it is sometimes unclear which office to call when an intellectual property issue comes up. The list on the right gives general guidelines for each office's area of responsibility.

## Areas of Responsibility: ORS/OSPRA vs. OTMS

### ORS/OSPRA

- Externally sponsored research agreements
- Non-disclosure agreements involving University research (company and University proprietary information being exchanged)
- Materials transfer agreements-**inbound**, covering materials being transferred by third parties into the University for use in University research programs
- Technical testing agreements
- Collaborative agreements including no-dollar agreements
- Federal CRADAs (Cooperative Research and Development Agreements)
- Center and consortium agreements
- Visiting scientist agreements
- Facilities use agreements

### OTM

- Non-disclosure agreements involving OTM-managed intellectual property
- Interinstitutional agreements
- Options
- Evaluation agreements
- Licenses

## Areas handled differently on the two campuses:

### ORS/OSPRA

- Materials transfer agreements-**outbound** -covering University materials transferred to colleagues and others outside of the University
  - » On the Chicago campus, ORS leads
- SBIRs and STTR's
  - » On the Urbana campus, OSPRA leads, with input from the OTM
- Intellectual Property Agreements and data sharing plans in center and consortium agreements
  - » On the Chicago campus, ORS leads

### OTM

- Materials transfer agreements-**outbound**
  - » On the Urbana campus, OTM leads
- SBIRs and STTR's
  - » On the Chicago campus, OTM leads
- Intellectual Property Agreements and data sharing plans in center and consortium agreements
  - » On the Urbana campus, OSPRA leads, with input from OTM

# Intellectual Property

## Defining Intellectual Property

Intellectual property encompasses all forms of creativity such as inventions, software, discoveries, creative or artistic works, know-how, processes, and unique materials. For example, intellectual property may be machines, devices, instruments, computer programs, circuits, biological materials, chemicals, books, videos, photographs, paintings, sculptures, or songs.

Intellectual property is protected by law through patent, copyright, trademark, and trade secrets. Multiple forms of protection may be used on the same piece of intellectual property. For example, computer software can be protected by copyright, patent, trade secret, and trademark. Intellectual property is also protected through agreements which control access and use of the intellectual property.

## University Ownership

Under the University's *General Rules*, the University of Illinois owns all intellectual property created by any University employee in the performance of employee duties at the University or created by anyone, including students and others, using University facilities, equipment, or funds.

The only exception under the *General Rules* is copyrights in traditional academic work, such as scholarly publications and course notes. Copyrights in traditional academic works made by faculty and students independently at their own initiative and for traditional academic purposes are owned by the authors. Examples include manuscripts, curriculum, books, lectures, and

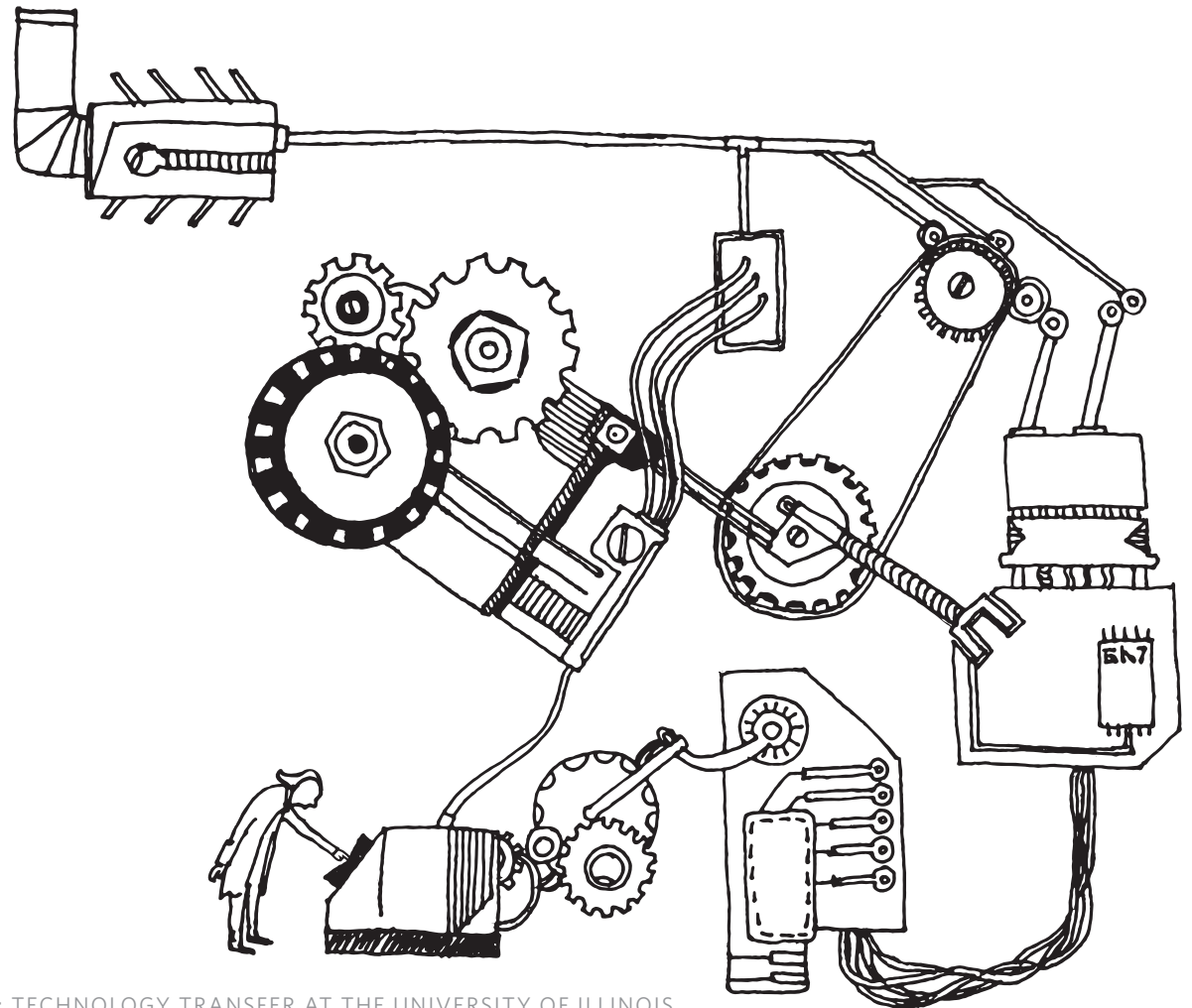

teaching materials for faculty, as well as class notes, reports, papers, and theses for students.

Note, however, if the University is the impetus for the creation of such work, it is not necessarily considered a traditional academic work. One example is when the University provides dedicated funding for the creation of a specific online course. Ownership associated with online educational tools and courseware has varied, often complex, ownership and usage rights depending on the circumstances of development and the use of University resources.

Copyright ownership and invention ownership may be different. While the author or authors own the copyright in a manuscript or paper describing an invention (because it qualifies as a traditional academic work), the University owns the underlying invention or software described in that paper. The University also owns the original records of the research, including laboratory notebooks.

## Student Ownership

Undergraduate students likely own their intellectual property because in most cases, students are only using University resources that are usually and customarily provided. Examples of resources customarily provided to students are office space, dorm rooms, library facilities, and ordinary access to computers and

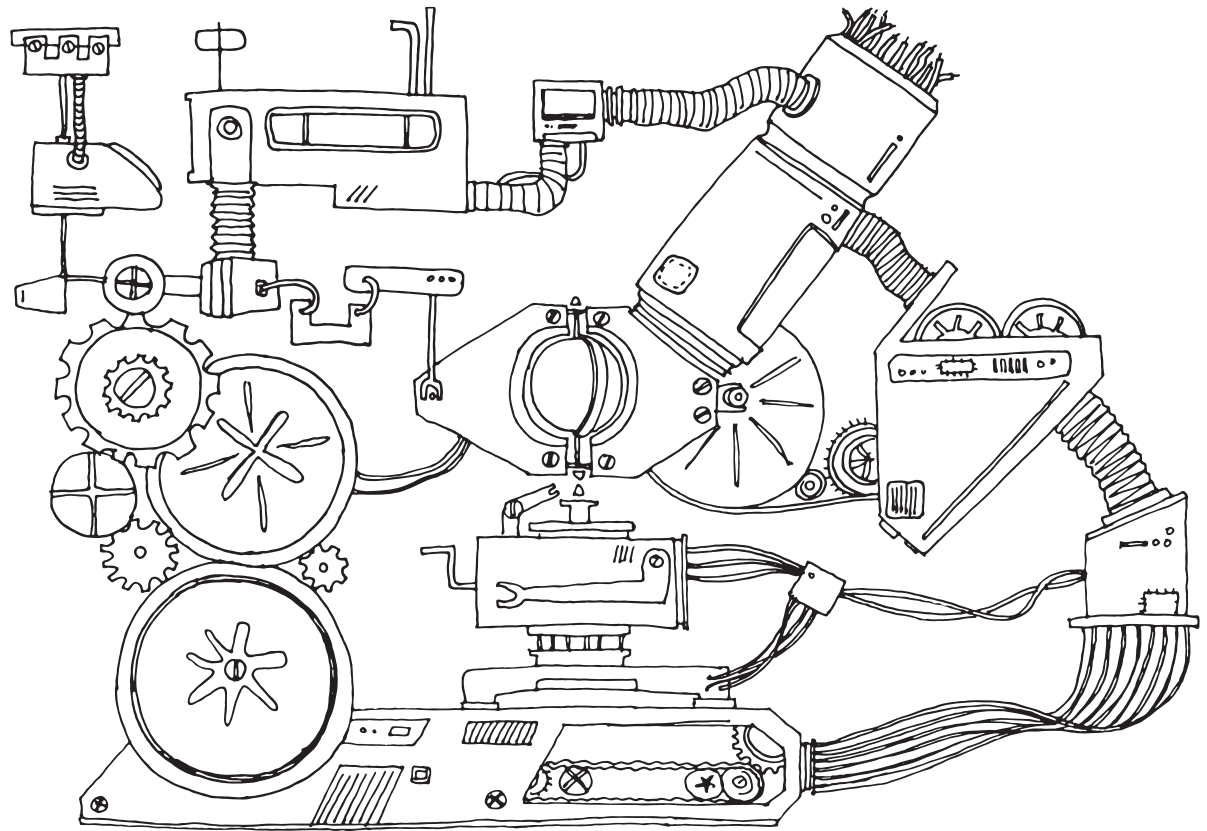

networks. However, when students create intellectual property using University facilities, equipment or funds, the standard University ownership rules apply.

### EXCEPTION TO STANDARD UNIVERSITY OWNERSHIP RULES FOR STUDENT ENTREPRENEURIAL ACTIVITIES

The University encourages student entrepreneurship and provides varied programs, resources and opportunities for students. To enable such opportunities, a limited exception

to the University's ownership policy may be applicable to student inventions that result from specific student class projects and entrepreneurial activities when certain criteria are met. The University may waive its right to own these student inventions. This exception only applies when the student invention arises solely from the class or activity and when the only University facilities used were those offered for the approved class or activity. **This exception does not apply if the invention incorporates, depends on or is derived from other University owned intellectual property.**

# Patents

## Inventions & Patents

**An invention is a device, method, composition, or process made by man, as long as it is new, useful, and not obvious.** Inventions may include many types of discoveries and technological innovations such as processes, methods,

machines, articles of manufacture, devices, chemicals, and compositions of matter. Inventions can be protected by patents.

The U.S. Constitution recognizes the value of innovation to the economy and provides the owner of a patent with a time-limited monopoly (20 years) to stop others from exploiting the invention. In exchange for this exclusive right, the published patent document must fully describe the invention in a way that allows others to reproduce and learn from it. In that way, the patent monopoly provides an incentive to share advances with the public and, thereby, contributes to growth in the field.

### Patentable Inventions

Most research conducted at the University can lead to inventions that may be patentable. A few examples are:

- **Engineering:** laboratory instruments, machinery, semiconductors and chips, manufacturing techniques, process improvements, nanotechnology, circuits, sensors, lighting, filtration, and micro-devices
- **Agriculture:** grain and food processing, germplasm and plant varieties, precision equipment, devices, and nutrition
- **Biotechnology:** genetic promoters, genetic markers, gene transfer methods, expression vectors, and microorganisms
- **Chemistry:** new compounds, new drugs, drug targets, drug design, separation methods, coatings, additives, superconductors, metals, polymers, and fuel cells
- **Software and Algorithms:** methods and processes in computer programs, operating systems, networking, data mining and storage, security, and supercomputing

### INVENTORSHIP

A patent application must be filed in the names of the true inventors. The legal criterion for inventorship does not equal those used for authorship. Inventorship is defined by U.S. patent law. **Broadly, an inventor is one who alone or together with others conceived the ultimate working invention.** Inventorship is not a reward for hard work to someone who only worked under direction. Inventorship is tied to the claims in a patent application and is determined at the time the patent application is filed. As the claims in an application change, so may inventorship. The OTMs refer the final inventorship determination to outside patent counsel.

### OWNERSHIP

Inventorship does not equal ownership. In most cases, organizations own the inventions developed by their employees. University of Illinois patents are owned by the University's Board of Trustees.

### THE STANDARD TESTS OF PATENTABILITY

For an invention to be patentable, it must meet the following three criteria for patentability:

**New or novel.** The invention must be different from all known inventions, products, and published ideas. This does not mean that every aspect of an invention must be entirely new or novel. You can selectively patent new aspects if they pass the following two tests.



# The America Invents Act, which became law in September 2011, enacted the most momentous change to the United States patent system since 1952.

**Non-obvious.** The invention cannot be an obvious or a logical extension of known ideas or inventions. It cannot be readily apparent to a person skilled in the field of the invention.

**Useful.** The invention must work and have a practical application or utility.

It is also possible to patent an improvement to existing inventions, if the improvement meets the above criteria. Furthermore, the patent application must fully enable someone to make and use your invention. This is called enablement.

## PUBLICATION AND PUBLIC DISCLOSURE

Publication and other public disclosure of an invention by anyone, including the inventor, if it occurs before a patent application is filed, may prevent the ability to obtain a patent.

## Withholding a Graduate Thesis from Publication

It is occasionally necessary to delay publication of a thesis for a limited period of time for the purposes of protecting potentially patentable inventions and complying with the terms of sponsored research agreements (such as prepublication review). A student's degree requirements can still be fulfilled even though publication of the thesis is delayed.

The optimal way to protect intellectual property and adhere to sponsor agreement requirements is to file a formal submission to your Office of Technology Management of a Thesis Withholding Request. This must be done prior to or concurrent with thesis deposit in the Graduate College and it delays the Graduate College's transfer of the thesis to IDEALS and ProQuest/UMI Dissertation Publishing. This mechanism provides an absolute "blackout" of information contained

in the thesis. The author, title, and abstract are not accessible in any way.

Upon filing a formal withholding request with your OTM, the Graduate College will not transfer the thesis until after the OTM has removed the withhold request. Once the withholding is removed, any access and embargo options selected by the student at the time of deposit will then be applied to the thesis.



## WHAT CONSTITUTES A PUBLIC DISCLOSURE?

**A public disclosure is any oral or written communication to others that is not confidential and either teaches the invention completely or provides enough information to make development of the invention obvious.**

In the U.S., a public disclosure may be any written document accessible by others such as manuscripts, abstracts, websites, meeting notes, or presentations. Simply telling a colleague that you have made an invention but not telling how to make or use it is usually not considered a disclosure that could prevent you from obtaining a patent.

## BEING FIRST

Not infrequently, two entirely different groups invent the same or very similar inventions.

What happens then? **In most of the world, including the U.S., the first inventor to file a patent application is entitled to the patent.**

This is referred to as a *first-to-file* system.

Prior to March 2013, U.S. patent law held that the inventor who could document that he or she was the first to conceive an invention was entitled to a patent. This is referred to as a *first-to-invent* system. The America Invents Act changed the U.S. patent system from *first-to-invent* to *first-to-file*.

To help avoid losing patentability due to public disclosure or not filing first, contact your OTM as early as possible in the invention process.

## PATENTS AS PROPERTY

A patent is property like a house or car that may be sold, leased, or rented to others for royalties. Patent rights are often transferred to others for commercialization through licensing (see licensing section) rather than outright sale. The patent owner can decide how to allow others to use his or her property and can divide up rights in the property in different ways. For example, exclusively or nonexclusively, by field of use, or by geographical region.

## Inventor's Notebook

The inventor's notebook is one of the best ways to establish intellectual property ownership.

### Keeping a Notebook

Laboratory notebooks documenting one's research are almost always kept to support publications. In the case of applying for a patent, it is recommended to keep the notebooks in a more structured way so they can be relied upon as evidence to support invention entitlement.

### Content

The notebook should be a dated, written record of all experiments, results (even if the significance is unclear), conversations (including who you talked to and what topics you talked about), thoughts, and future directions of investigations.

### Certification

A credible witness who is not a family member or notary public should be chosen for his or her knowledge and ability to read and understand the concepts and principles in the notebook.

**Inventions that are not patentable include laws of natures, theories, scientific principles, pure algorithms and perpetual motion machines.**



# Patent Application Process

**Obtaining a U.S. Patent starts with the filing of a non-provisional patent application that includes a specification describing how to make and use the invention and one or more claims that define the scope of what is new about the invention.** The claims are used by courts to determine invention infringement.

This application is filed in the United States Patent and Trademark Office (USPTO) and assigned to a patent examiner who specializes in the particular technology area. The examiner considers the scope or breadth of the claims against prior patents and publications. They then issue an office action accepting (rarely) or rejecting (typically) the claims (some or all) as not distinguishing over what is already known. In the case of claim rejections, the patent attorney, with the assistance of the inventor, rebuts the examiners' arguments and/

or responds with modifications (amendments) to the claims. Two to three iterations are typically required to obtain allowance of the patent application. Once issued, generally a patent has a life of 20 years from the filing of the first regular patent application. In the U.S., maintenance fees are required at 3½, 7½, and 11½ years to keep the patent in force.

A provisional application can be filed in the U.S. before the regular application to stake a claim to

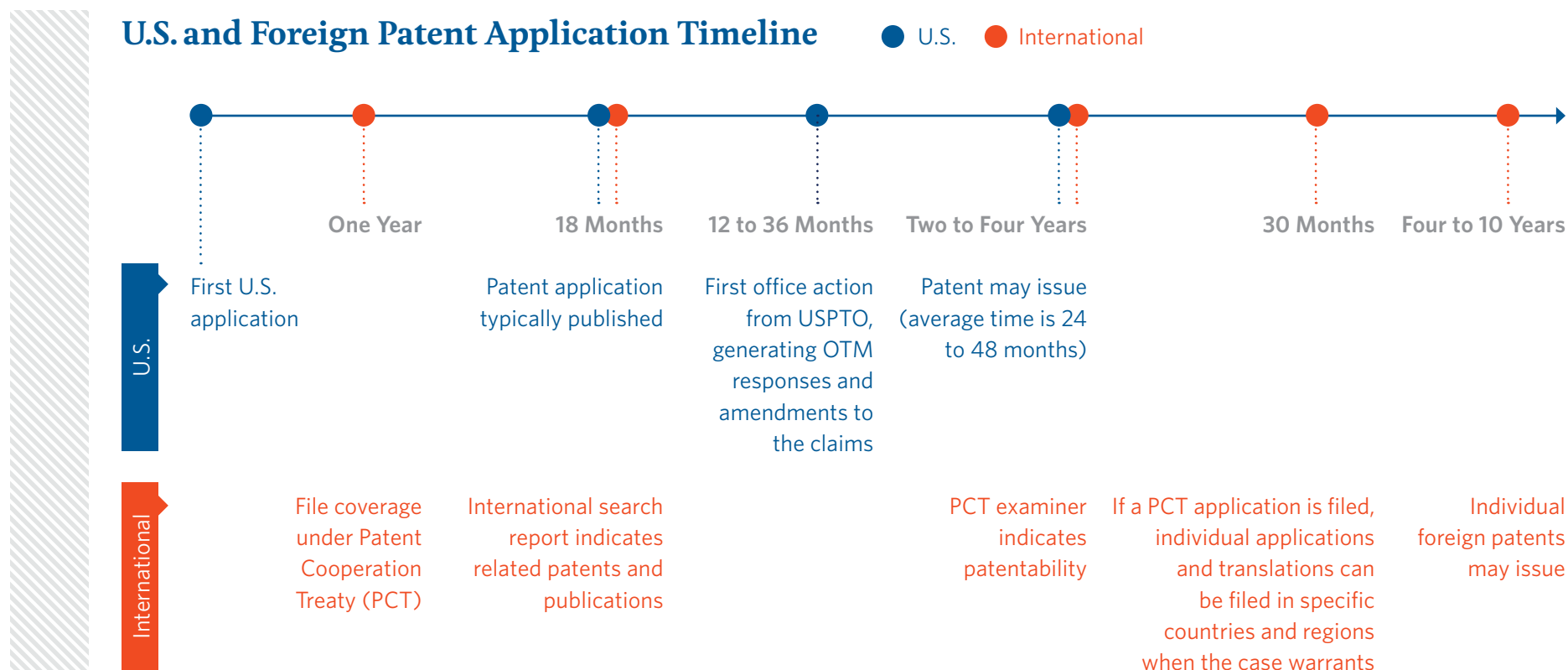



an invention. This type of application does not require claims or get examined and becomes abandoned within one year of filing unless it is converted to a regular U.S. application or a Patent Cooperation Treaty (PCT) application within one year of filing. It is often used to extend patent life for an additional year.

A PCT application is an international place holder application filed in the home country of the inventor that reserves the right to file in the U.S. and many foreign countries at a later time. Just like provisional applications, PCT applications will never issue as a patent and will become abandoned if they are not converted to regular applications in the U.S. and each foreign country in a timely manner.

The first U.S. application can be filed in the USPTO either as a provisional, regular, or PCT application.

## Patent Decisions

Decisions to file a patent are made by the OTMs. These are business decisions based on market considerations, necessity of protection, probability of success in licensing and recovering expenses, and potential market impact. There is an expectation that all patents filed are potentially commercially valuable enough to recoup at least the patent expenses.

Periodically the OTMs review their patent portfolios and in cases where the patent is not

licensed the OTMs assesses whether to continue prosecution or maintenance.

### U.S. PATENT DECISIONS

The OTMs pursue U.S. patents on a variety of innovations. University technologies are usually very early stage and well in advance of being ready for the market. The OTMs' process removes technologies that are not patentable, cannot provide an exclusionary position, are in a technology area that has been unsuccessfully pursued before, or are in a market area where investment cannot be justified.

### INTERNATIONAL AND PCT APPLICATION DECISIONS

International patents involve escalating expenses, and, as a consequence, the OTMs are much more selective in decisions to file international applications than U.S. applications.

Generally, the Offices pursue PCT and foreign applications when the technology has been licensed and the licensee pays for it, or in cases where there are significant foreign markets.

### FOREIGN COUNTRY AND REGION SPECIFIC PATENT DECISIONS

Converting a PCT application into a specific foreign country or regional application (or filing in those countries directly without having filed a PCT application) has much greater cost implications than the decision to file in the U.S. This is primarily because of the combination of the country-by-

country amplification effect and the necessity for translations and additional attorneys. Furthermore, because the laws in foreign countries vary with respect to the value patent protection affords the owner, the value of foreign protection may be less than the corresponding value in the U.S.

## Timing

The average pendency of a patent application in the U.S. is between two and four years. Inventors in the biotechnology and computing fields, however, should expect longer waiting periods.

## Cost

Filing and obtaining U.S. patents generally costs between \$20,000 and \$30,000. Filing and obtaining patents in other countries may cost \$30,000 or more per country. Maintenance fees or annuities are also required at 3½, 7½, and 11½ years in the U.S. and more frequently in foreign countries.

# Copyright & Trademark

## Copyright

**Copyright is the form of intellectual property that protects the expression of a creative idea that is fixed in a tangible form.** It is like an acknowledgement of who created the work.

For example, in *The Wizard of Oz*, copyright protects the order of the words in the story, as well as the layout of pictures, colors, and words on the page. The ideas, the plot, or the characters are not protected. Each adaptation of this classic tale (book, screenplay, movie, music) generates independent copyrighted works.

For scientific writings, copyright does not protect the procedures, systems, processes, concepts, formulas, discoveries, or devices described in the work. Similarly, for software, copyright does not protect the underlying concepts, processes, systems, algorithms, program logic, or layouts.

Copyright is literally the right to copy, which includes the right to display, perform, distribute

copies, and make changes to the original copyrighted work. Changed versions of a work are known as derivative works. A copyright provides the owner with the right to determine how the work is copied and distributed to others, such as through traditional or online publication, open access, sale, lease, or lending. Copyright owners also determine whether a fee is charged for access to their work.

### COPYRIGHT APPLIES AUTOMATICALLY

Unlike patentable inventions, copyrighted works are automatically protected under U.S. copyright laws without having to undergo a formal registration process. However, it is still important to affix an appropriate copyright notice so others are aware that they are not free to use the work without permission. Works owned by the University should bear the following copyright notice: © 20XX The Board of Trustees of the University of Illinois. All rights reserved.

There is also a formal registration process to document copyright in the Library of Congress.

Author owned copyrights last for the life of the author plus 70 years after the last surviving author's death. Employer owned copyrights lasts for 120 years from creation or 95 years from the first publication of the work, whichever is shorter.

## What can I copyright?

### Copyrightable

Literary works: books, poems

Computer software: object code, source code

Music: notes, words, sound recordings

Plays: dances, pantomimes

Art: paintings, graphics, sculptures

Motion pictures

### Not Copyrightable

Ideas or concepts

Factual information

Listings without originality (phonebook)

Titles or short phrases

Type styles

Public domain information

Slogans



# THE **Technology Transfer** PROCESS

## The Offices of Technology Management

The Offices of Technology Management are responsible for managing the intellectual property generated by research and educational activities at the University of Illinois.

The Offices' missions are to encourage innovation, enhance research, and facilitate economic development through the transfer of intellectual property.

The Offices have developed a documented, systematic, and timely process for the analysis, protection, and commercialization of intellectual property.

### INTELLECTUAL PROPERTY DISCLOSURES/REPORTS OF RESEARCH DISCOVERIES

Both OTMs actively reach out to faculty to encourage disclosures of new innovations.

**A disclosure is a written statement outlining a new innovation and documenting the**

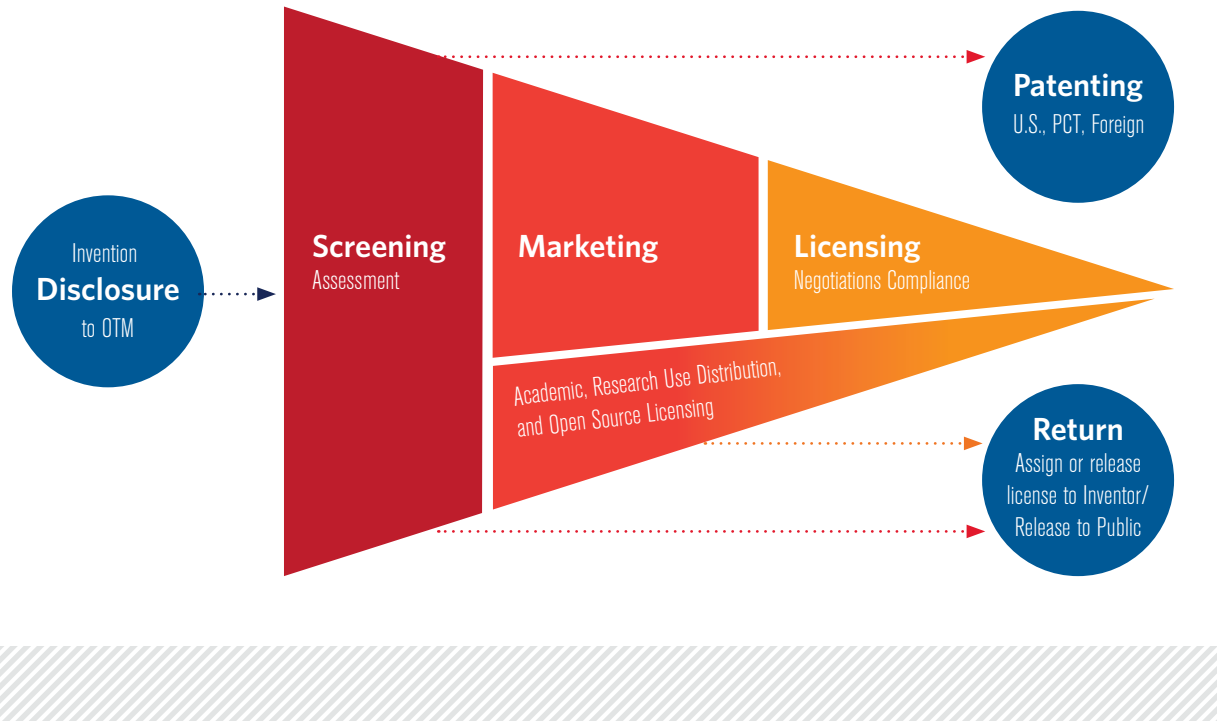

**circumstances of its development.** The disclosure also identifies potential applications and what companies might be interested in licensing the IP if that information is known. Forms can be found on the OTMs' websites.

Disclosure forms help the OTMs begin the process of evaluating the technology transfer potential for the intellectual property and complies with the obligations of Bayh-Dole. A technology manager is assigned to guide a disclosure through the technology transfer process.

Submitting a disclosure form to your OTM does not by itself protect the intellectual property. Only a patent or a copyright can do that. Also, disclosure to your OTM is confidential. It is not considered a public disclosure under patent law. A disclosure to someone outside the University is a public disclosure unless you have a confidentiality agreement.

### SCREENING EVALUATION/ASSESSMENT

Through the screening review process, the decision to pursue or abandon commercialization efforts for a technology is made.

Within six to eight weeks of receiving a disclosure, OTM's staff completes a business-case analysis, called a screening evaluation, with a recommended course of action on commercialization. The results of the screening evaluation, which include patent searches, marketplace analysis, and identification of possible licensees, are then shared with the inventors.

### PATENTING DECISIONS

For technologies the OTMs decide to patent, an initial patent strategy is identified (see *Patent Decisions*, page 17). In most cases, an independent patent law firm is hired to prepare and prosecute the patent application.

### MARKET ASSESSMENT

Detailed analyses, sometimes through the engagement of outside consultants who connect with industry experts, add to the OTMs understanding of the potential market for the technology and help determine further patenting and marketing actions. Inventors themselves often help enormously in finding interested licensees because they have many contacts through their own research.

### RELEASE LICENSE OR ASSIGN TO INVENTOR

If the OTMs decide not to pursue or to discontinue pursuit of commercialization efforts on an innovation, they will release the invention and may assign the University's ownership rights

to the inventors if the inventors are interested in pursuing a patent and commercializing the innovation independently. For any federally

funded invention, the federal agency must approve the assignment, which may take a few weeks or months to finalize.

## Technology Transfer Q&A

### Q: Can I still publish my findings?

Yes, findings can still be published, and disclosure to your OTM does not alter your publication timetable. However, because publishing can affect the ability to obtain a patent, it is best to submit a disclosure prior to publishing or communicating your findings in a public forum.

### Q: When should I submit a disclosure?

It is best if inventors submit a disclosure between eight and 12 weeks before publication so that, if necessary, actions can be taken to protect both U.S. and foreign rights. Once publicly disclosed, an invention may not be patentable. To be safe, inform your OTM of any imminent or prior presentations that include the IP.

### Q: What is my role in the screening process?

Inventors typically meet with OTM staff to discuss the invention and clarify aspects of the disclosure. Once a decision is made on whether to pursue patenting, the inventor will be contacted to discuss the outcome.

### Q: What is my role in patenting?

Inventors and OTM professionals speak with the patent attorney during the patenting process. Also, inventors will need to review drafts of documents, as well as sign assignments and other legal documentation. OTM will guide the inventors during the process.

## MARKETING (SEEKING PARTNERS)

OTM staff engage in a variety of marketing activities to advocate for University research and intellectual property. Considerable time and resources are devoted to understanding market needs and contacting potential partners either

to license existing technologies or to cultivate relationships, such as sponsored research, that may lead to licenses. The best tools to market a technology vary from industry to industry, therefore each OTM engages in a variety of activities depending on the situation and technology.

These activities may include:

- showcasing University technologies to venture capitalists, investors, and corporate representatives through OTM-hosted events on campus and around the country
- attending tradeshows and professional meetings

## Technology Transfer Q&A (Continued)

### Q: What is my role in marketing?

Inventors are encouraged to work closely with their technology manager to market their invention. Inventors are often quite involved in the early stages of recruiting commercial partners and licensees, as the inventor's expertise is often critically important. This involvement includes exchanging information and materials, and sometimes results in further sponsored research (dubbed pre-licensing agreements). Inventors are often involved in crafting the details of such pre-licensing agreements.

### Q: What is my role in licensing?

Licensing is the primary function of the OTMs, and inventors will be informed of progress. Inventors often are closely connected to others in their field and may be consulted by their OTM on the business terms of the license.

Further, the inventor's role in licensing is an extension of their role in marketing since their expertise is often critically important to transfer the technology and related know-how to the licensee. The University license places only nominal obligations on the part of the inventor to assist in the transfer of the licensed technology. When more than minimal time and effort is necessary, the licensee will negotiate a separate consulting arrangement with the inventor.

### Q: What effect does a license have on my ability to do research?

You can still continue research using a licensed invention, even if it is exclusively licensed. The University will always retain the right to use licensed inventions in academic research and teaching.

### Q: What if an industry partner funded my research and invention?

Your OTM will review the terms of the contract, send a copy of the disclosure to the company, determine the company's interest, and take action based on the company's decision.

- making calls and sending collateral materials
- producing brochures and sellsheets
- maintaining websites
- sending press releases
- using social media to cultivate contacts
- creating campaigns to promote a portfolio of technologies
- hosting events on campus so that inventors can get to know our services

Finding partners often takes time, since many University innovations are on the cutting edge and well in advance of the needs of the marketplace. The OTMs work with inventors and others to determine the best time to market a technology.

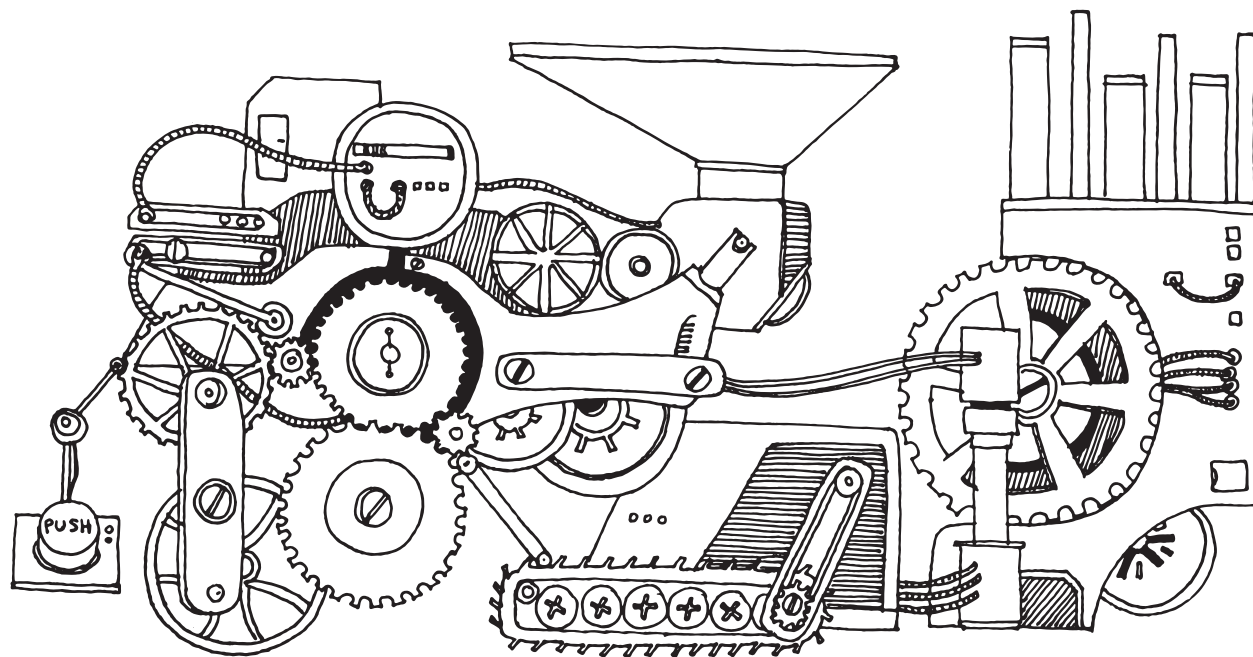

Both campuses  
are developing  
sustainable sources of  
funding for proof-of-concept  
development.  
Talk to your OTM for more  
information.

## MARKETING RELATED AGREEMENTS (PRE-LICENSING)

Once a potential corporate partner is identified for a technology, **non-disclosure agreements** are used to protect the confidentiality of any non-public information. **Materials transfer agreements** and **evaluation agreements** may be used to provide companies with certain rights to use the technology for short term evaluation purposes only.

**Option agreements** reserve the right of a company to negotiate a commercial license. Options may be stand alone agreements

negotiated directly through the OTM, or they may be clauses contained in other agreements such as sponsored research agreements or the above pre-licensing agreements.

If intellectual property is developed by more than one institution, an **inter-institutional agreement** is often negotiated to set out the terms under which the two universities will cooperate to assess, protect, market, license, and share revenues from the jointly-owned property.

## LICENSING

**A license is the technology transfer agreement granting some of the University's rights as owner of an intellectual property (licensor) to a company who has agreed to certain obligations and responsibilities to commercialize the intellectual property (licensee).** The University licenses its varied technologies (patents, software, databases, copyrights) to companies who demonstrate the capability and commitment to develop the early stage innovations into commercial products. Sometimes both the inventors and the University agree that the best entity to bring a technology to market is a start-up company.

Whether the licensee is an existing company or a start-up, licensees also demonstrate such commitment by providing a written technology development plan to the University. This plan should include, but not be limited to, a description of the technologies to be licensed, the resulting product, market analysis, a product development timeline and the company resources committed to development. The terms of the license are negotiated based on the licensee's plan.

## LICENSE COMPLIANCE

After a technology is licensed, the Offices manage the license to ensure all terms and conditions are adhered to and the technology reaches its fullest

potential. If the licensee does not comply, steps may be taken to terminate the license, in which case the invention would be available for licensing to another company.

## LICENSE NEGOTIATIONS

The licensing process begins with negotiations with interested industry partners, including start-up companies in which term sheets summarizing the essential business terms of the licensing agreement are exchanged. Below are the types of business terms generally addressed.

### Scope of License Rights

License rights such as exclusive, nonexclusive, field of use limitations, and territory limitations are established to be commensurate with the licensee's product development plans and the market. The University's licensing objective is to obtain widespread use of its technologies.

### License Fee

Together with the royalties and other monetary terms, the value depends on the scope of the license rights and the market value of the technology licensed.

### Royalties

Royalties are paid by the licensee when products or services that require the use of the technology are sold. Royalties can be expressed

as a percentage of sale or a fee per selling unit. Royalty rates vary according to the industry, the significance of the invention, and the base upon which the royalty is applied (e.g. unit, component, subsystem).

### Sublicense Sharing

Exclusive licenses usually provide the licensee with the right to sublicense, or authorize others, to make, use, and sell the University's technology to facilitate widespread use. Revenues received by the licensee from sublicenses are shared with the University.

### Minimum Royalties

Minimum royalty payments are established to encourage diligence in sales of products or services requiring the use of the technology.

### Patent Reimbursement

Recovery of the costs incurred for protecting the technology in the U.S. and other countries are part of the license.

### Performance (Diligence) Milestones

University technologies often require a significant period of time and effort in product development before they are ready for the market. During the development phase, licensees are required to provide periodic reports and meet specific milestones in order to retain a license, especially an exclusive license.



## REVENUE SHARING

**When an invention, software or other intellectual property is successfully licensed, or commercialized, the net revenues are shared with inventors and creators.**

Inventors receive 40% of revenue after deducting expenses (such as costs for protecting the intellectual property), the inventor's department or unit receives 20%, and the University receives 40%.

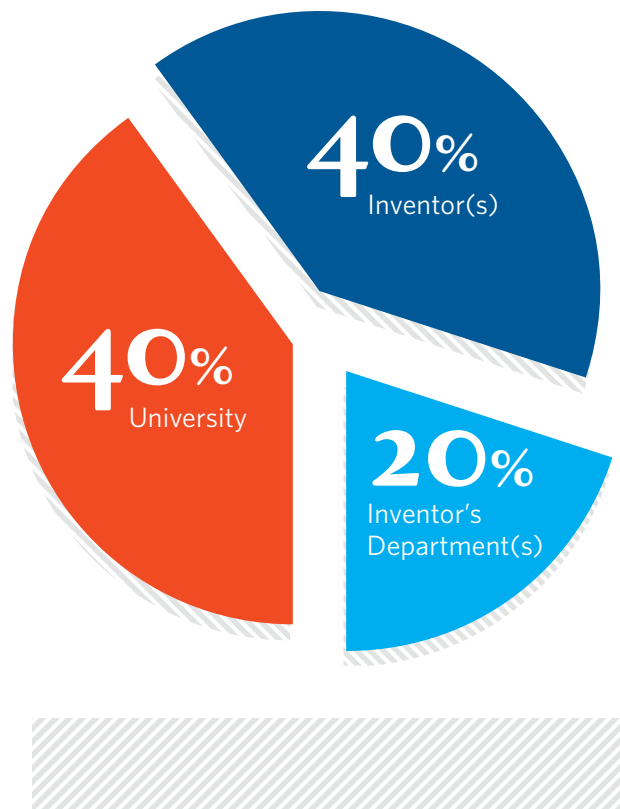

Agreed allocations are formalized in a proceeds distribution agreement. The proceeds distribution agreement also addresses the shares among multiple departments or units, using the recommendation of the inventors and the concurrence of the associated departments or unit heads.

### How is Equity distributed?

Equity from a license is shared with inventors when it is cashed in by the University. The money is distributed according to the proceeds distribution agreement, under the same sharing formula as royalties.

### What are the tax consequences?

Licensing revenues are considered taxable income. The University reports licensing revenue paid to inventors as income on Form 1099. Your tax advisor can provide specific advice.

## Other Methods of Innovation Transfer

Certain types of intellectual property, such as copyrighted software, copyrighted content, and biological materials, are commonly disseminated to the public through ways other than traditional licensing on a royalty or revenue generating basis.

The Offices of Technology Management handle more than just traditional licensing and, in fact, work with faculty and staff across all departments to help disseminate copyrighted works, software, data, code, materials, and research results outside the University for greater impact.

## ACADEMIC AND RESEARCH USE, CREATIVE COMMONS LICENSING, AND OPEN SOURCE LICENSING

Other common ways of transferring University intellectual property include:

- **Academic and Research-Use licenses:** often used for software, biological materials and data sets; allows uses by other institutions for academic purposes only
- **Creative Commons licenses:** often used for literary and artistic works; has a matrix of options for both academic and commercial uses
- **Open Source licenses:** often used for software; makes source code freely available for commercial and non-commercial use under certain conditions

All of the above licenses retain copyright for the creator and stipulate proper attribution. Even though such transfers and dissemination are not revenue generation to the University, **they promote visibility and public use of University research and potentially aid in the University's mission for public good.**

When choosing between academic, creative commons, and open source licensing, the OTM can assist creators in deciding which option is the best for their specific situation.

**Academic and Research-Use licenses** permit research institutions or individual researchers to use a program or material free of charge or at a research-use rate, but do not permit those

institutions to transfer the software or materials to third parties or make commercial use out of the technology. Such research use licenses also leave open the possibility of future traditional revenue generating commercial licensing.

## Open Source Q&A

### Q: What is the Open Source?

In the software community, Open Source is a forum in which multiple unaffiliated parties have access to the source code of a software program for the purposes of collaborative development. People who participate in the Open Source believe that more scrutiny brings greater reliability and that software is an evolving entity that can achieve its fullest potential without the restrictions of commercial sale.

### Q: What's my role in open source licensing?

As with decisions for publication, the faculty or head of the research program makes the recommendation for open source dissemination. Often, the decision to release code into the open source is made early in the software development process: as a condition of the funding, as a requirement of participation in the software community, or as a consequence of incorporating third party code that requires placement in the open source.

When software is placed in the Open Source, it is usually through the University of Illinois or NCSA Open Source License. This license places minimal restrictions on use, thereby maximizing flexibility of use and dissemination. The University of Illinois license can be viewed at <http://www.opensource/licenses/UoI-NCSA.php>.

**Creative commons licenses** are a matrix of licensing allowing free use and sharing (redistribution) of a copyrighted work with proper attribution. The options include whether modifications to the work can be made, whether the work can be used for commercial purposes, and whether further sharing of the work must carry the same options for re-distribution.

**Open source licenses** allow free and less restricted distribution of software, including commercial use, and promote testing and further development and adoption of the software in a collaborative environment. Most federally funded research in software development requires open source dissemination. However, open source licenses may limit future proprietary commercial licensing potential.

## MOBILE APPS

The University has signed the iOS Developer Program License Agreement and the Android Market Developer Distribution Agreement.

**Your OTM can help you get access to iOS and Android developer tools and manage the submission of University-owned apps to Apple's App Store and the Android Market.**

# Consulting

& INTELLECTUAL PROPERTY

## Faculty Consulting and the University

Faculty consulting often enhances the skills and reputation of the faculty, is a benefit to the University, and provides a public service. Faculty are expected to arrange their consulting activities so as not to conflict with University duties and responsibilities.

**Your OTM is happy to talk with you about consulting agreements, but please keep in mind that the Office cannot provide legal advice on these documents, and this overview is not considered legal advice.**

The following overview provides information about the general terms and conditions of consulting arrangements, as well as identifies areas of overlapping obligations and responsibilities that may arise when undertaking consulting work.

### SCOPE OF WORK

A clearly defined scope of work is often the best way to avoid overlapping intellectual property and

research obligations. The scope of work should be limited to the specific work to be performed. It is best to avoid overly broad statements, such as “other services as may be requested from time to time” or “services in the area of cancer research,” as these may encroach on your University research areas.

### INTELLECTUAL PROPERTY

Often consulting agreements require that the company own the intellectual property developed by the consultant. This requirement may be difficult to comply with when the area of consulting overlaps with the faculty member’s area of research. Narrowing the scope of work (such as only to company proprietary innovations) may help.

The consulting agreement should not convey to the company any rights in intellectual property developed using University facilities or developed under University grants or contracts. Make the client aware of your University obligations related to ownership of intellectual property. Watch out when the consulting agreement asks for rights to improvements or future inventions in the area, so you don’t put your related research programs at risk. If the company owns it, you do not have a right to use it in your research.

In view of recent court decisions (e.g., *Stanford v. Roche*), the OTMs urge you to pay attention to wording that may diminish your rights and the University’s ownership in existing IP.

### CONFIDENTIALITY

Typically, the consultant must have access to company proprietary information that the consultant must keep confidential. Be specific about what information is to be confidential. If there is potential for overlap in research, ensure you have continued rights to publish.

### EXCLUSIVITY

There may be provisions that restrict the consultant from providing advice or working with other companies. This may impact the faculty’s ability to work with other corporate sponsors within the University.

### LIABILITY AND INDEMNIFICATION

The consultant has no control over what the company does with the advice and services he or she provides. Therefore, it is advisable to include a provision that limits the consultant’s liability and expressly disclaims liability for any products produced by the company. Further, the company should indemnify the consultant for any third party claims or actions related to the consulting services. Since consulting work is private, it is not covered under the University’s general insurance. If there is a potential for liability, the consultant should check whether his or her personal liability policies would cover such claims.

# Starting a Company

Starting a new company is one way to further develop and commercialize technologies created at the University of Illinois. **A start-up can be a preferred route for commercialization because it can provide the professional guidance and development needed to demonstrate commercial viability, and thus improve the chances that an early-stage technology reaches the market.**

Numerous resources exist within the University system to support the development of new businesses commercializing University intellectual property. IllinoisVENTURES is a premier seed and early-stage technology investment firm focused on research-derived companies. It was launched by the University, and has been consistently named by *Entrepreneur magazine* to its national list of the top 100 venture capital firms. In addition, Research Park and incubation facilities on both campuses provide the physical space and the environment to foster start-ups.

Many factors are involved in the OTM decision to license a technology to an existing company or to a start-up company. Considerations include

optimization of stakeholder positions (University, faculty, etc.), improvement of the probability that the technology will reach the market, and techniques to accomplish further commercial development outside the research laboratory. The licensing or optioning process begins with somewhat standardized templates that tend to provide both equity and royalty consideration to the University in exchange for commercial rights to the technology.

## **When a start-up includes one or more University faculty members, a conflict of interest management plan is required.**

That plan outlines the relationship between a faculty member's activities with the company and his or her research and teaching responsibility. The plan identifies and mitigates possible areas of conflict, such as those related to conflict of commitment and/or conflict of interest and lays out a plan for disclosure and management of these conflicts. To initiate a conflict of interest management plan, contact the Office of the Vice Chancellor for Research. See box on page 30 for more information.

## Start-Up Q&A

### **Q: What is a start-up company?**

A start-up company is a new business entity created to market a specific invention. It is an alternative to licensing an invention to another already existing company.

### **Q: What role does the inventor play in the start-up company?**

The inventor usually serves as a consultant or adviser to the new company. That role may change as the company develops. However, much more time is required early in the process of establishing the company.

### **Q: What support does the University provide to start-ups?**

The University provides resources and services that make start-up formation easier, such as IllinoisVENTURES and incubation facilities.

University licenses to start-ups are structured so as not to overburden the company financially during the first years.

# Start-Up Company Formation Guide and Checklist

- Review the company's business model with professionals to determine whether a viable business case is possible. IllinoisVENTURES and the Offices of Technology Management can help with the review.
- **Let your OTM know you are interested in forming a start-up.** You may then want to enter into a standstill or option agreement to ensure the University won't license the technology to any third party. This allows time for an individual or a company to develop a business plan and satisfy other licensing requirements.
- **Develop a preliminary business plan and submit to your OTM.** The business plan should include a business description, market analysis, management team, financial plan, and marketing plan.

The plan should also identify what technologies are needed and their benefits to the company. The business plan needs to be specific enough that the OTM and the company can begin to negotiate the deal framework and to identify meaningful milestones for the license.

- **Negotiate a license deal framework with the OTM.** The deal terms represent a package whose value depends upon the type and significance of the technology being licensed and external market factors. Components of the package include exclusivity, field of use, equity, royalty rates, sublicense sharing, diligence milestones, minimums and other payments. The terms are interrelated, and there is trade-off among terms in arriving at the entire deal. Equity is typically taken in start-up company deals in exchange for lessening the cash burden on the company in the early years.
- **Seek conflict of interest management plan approval.** When a start-up company involves a University faculty member, a plan is developed describing the relationship between the company and the faculty's University research and students. This plan identifies and mitigates potential conflicts of interest and should be initiated as early as possible with the Office of the Vice Chancellor for Research.

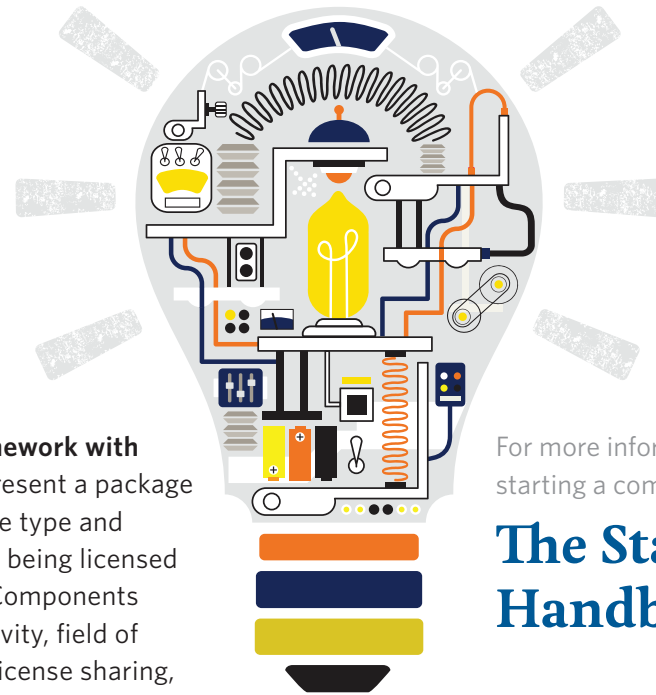

For more information about starting a company see

## The Start-Up Handbook

- **Establish company as a legal entity.** A license for a technology will only be granted to a company demonstrating the capability of developing the technology into a commercial product. Documentation needed includes articles of incorporation, bylaws, and founders agreements or equivalents.
- **Finalize the license agreement.** License drafts are exchanged, and the final deal terms and contract language are negotiated and agreed upon.
- **Complete a business plan** acceptable to the University.

- **Finalize the investment agreements.**

Investment documentation and agreements are reviewed and approved by the University and should be ready for signings. These types of agreements can include, but are not limited to:

- » Charter (Articles/Certificate of Incorporation)
- » Rights Agreement
- » Stockholders Agreement

- **Have experienced management on board at the time of signing the license agreement.**

If that management is on an interim basis, specify that a qualified management team will be assembled within a period of time after execution of the license agreement.

- **Provide a capitalization plan and capitalization table.**

A start-up must disclose the current levels of financing, equity value, or capitalization at the time of license signing and must reach specified levels of such financing within an agreed-upon time.

- **Sign license and investment agreements and provide stock certificate.**

- **Monitor agreements.** The company, the University, and the investors monitor company progress toward commercialization obligations and milestones.

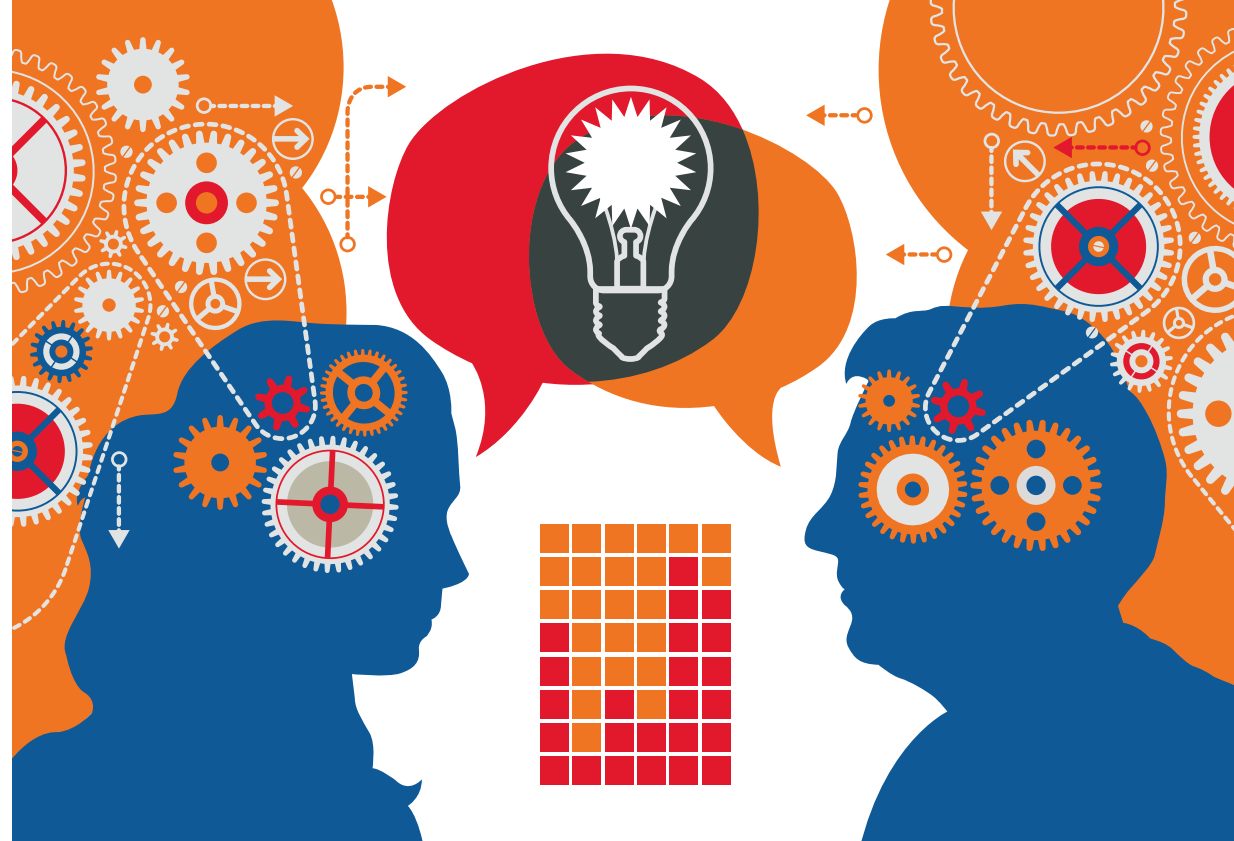

## Conflict of Interest Faculty Responsibilities

- Obtain prior written approval to engage in non-University income-generating activities.
- Disclose such activities annually, whenever a substantial change occurs, or when required by granting agencies.
- Refrain from spending so much time on external activities that they interfere with University responsibilities.
- Refrain from advancing one's own interest or the interest of family members to the detriment of the University's interest.
- Disclose involvement of University students or employees in one's external activities.
- Work with your department head to identify and evaluate potential conflicts and manage or eliminate them.

# IllinoisVENTURES

The Board of Trustees of the University of Illinois launched IllinoisVENTURES in 2002 to catalyze the creation and development of research-derived technology companies.

Under the guidance of a world-class board comprised of leaders from all phases of the investment community as well as academia, **IllinoisVENTURES has created a state-of-the-art environment for new company formation via a unique public/private partnership that is a valuable resource for those interested in starting a company.** In 2004 IllinoisVENTURES raised their first venture fund, the Illinois Emerging Technologies Fund, in recognition of the limited presence of seed and early-stage technology investors actively committing capital in Illinois.

To date, IllinoisVENTURES has formed and supported an array of companies in multiple business domains throughout the region.

IllinoisVENTURES provides guidance to faculty in early market assessment, competitive analysis, business strategy, and other activities necessary to create high potential, venture-ready businesses. The firm also provides funding through all stages of business creation and development. IllinoisVENTURES has offices in Champaign and Chicago.

## About IllinoisVENTURES

- **Total assets under management:**

**\$65** MILLION

- **Stage:** Origination and early-stage venture capital
- **Focus:** Research-derived investment opportunities
- **Industries:** Information technology, physical and life sciences, cleantech
- **Geography:** Illinois and the Midwest

## Building on University, State, and Private Investment

- Consultative interactions with over 3,000 technologies since 2002.

• **ATTRACTED**  
**\$650**  
**MILLION**

3rd-party  
co-investment  
in holdings—  
over 13:1  
leverage

- Created more than:

**450** high-value jobs

- Invested over \$45 million in 75 companies, often acting as co-founder

- Ranked **#1** in gap funding for third-party capital attraction by Innovosource

# Research Parks and Incubator Facilities

University-associated research parks and incubators at Urbana-Champaign and Chicago support and nurture the growth of early-stage companies, encourage research and development collaboration between the University, private industry, and public agencies and attract

## University of Illinois Research Park

2013 Three College-Town Incubators to Watch  
by *Inc. Magazine*

★★★

2013 Twelve Business Incubators Changing the World  
by *Forbes*

★★★

2011 Outstanding Research Park of the Year  
by the Association of University  
Research Parks

established companies that benefit from close working relationships with University faculty and students. These research parks provide critical infrastructure space for early-stage companies that require wet and dry laboratory capacity for product research and development.

### UNIVERSITY OF ILLINOIS RESEARCH PARK & ENTERPRISEWORKS

The Research Park at the University of Illinois at Urbana-Champaign provides an on-campus environment where technology-based businesses can collaborate on research and development with faculty and students, as well as enjoy access to the campus' vast intellectual resources and research infrastructure.

The Research Park is now home to a range of companies employing many people in high technology careers.

**EnterpriseWorks is a 43,000 square foot start-up business incubator in the Research Park for early stage tech firms.** It is owned and operated by the University of Illinois to help launch successful start-up companies. Since the incubator opened in 2003, its incubator facilities have become the launching pad for hundreds of start-up companies.

EnterpriseWorks provides an ideal environment for starting a high-growth technology venture with 24 full wet-labs, furnished office space, an extensive array of shared equipment, server co-location facilities, and conference rooms with complete presentation facilities and high-speed wireless Internet access. EnterpriseWorks offers many support services for its clients including:

- **Entrepreneur-in-Residence Program:** Local experienced technology entrepreneurs provide monthly consulting to new startup ventures and prospective technology entrepreneurs.
- **I-Start Professional Service Assistance:** A matching award program targeted to researchers that have a strong potential for technology commercialization through new company formation. I-Start offers a suite of first-year professional startup services for new University of Illinois entrepreneurs. This includes business development, legal setup, SBIR application, bookkeeping assistance, and marketing assistance.
- **NSF I-Corps Site:** A public-private partnership program launched in 2013 that teaches university entrepreneurs to identify valuable product opportunities that can emerge from academic research, and offers entrepreneurship training to students.



## Additional Resources from EnterpriseWorks Urbana

- Start-up Café events with successful company founders
- Allied agency status for companies with the University
- Research support services from the Vice Chancellor for Research
- CEO roundtable dinners for networking and peer-to-peer support
- Entrepreneur pro bono legal services

## ENTERPRISEWORKS CHICAGO

EnterpriseWorks Chicago creates a vibrant entrepreneurial ecosystem that engages the entire University of Illinois at Chicago campus, leverages University of Illinois system-wide assets, connects resources within and beyond the University to support emerging technology companies, and shares economic benefit with the greater Chicago community and the state of Illinois.

### EnterpriseWorks Chicago executes this function around five pillars of an entrepreneurial ecosystem.

- **Talent**  
EnterpriseWorks Chicago will educate inventors on the business of commercialization and create entrepreneurial experiences for students to develop broader skills. Providing access to entrepreneurs-in-residence, mentors,

industry experts, and functional specialists will cultivate new talent and create an environment that, in turn, will attract serial entrepreneurs and fill the talent pipeline for emerging technology companies.

- **Innovation**  
EnterpriseWorks Chicago will serve as a vehicle for innovation, finding commercial potential through company formation and start-up ventures.
- **Infrastructure**  
EnterpriseWorks Chicago will work to develop and revitalize incubation offices and laboratory facilities, implement training and support programming, and provide an operational infrastructure to serve as a hub for a robust entrepreneurial ecosystem.
- **Networks**  
EnterpriseWorks Chicago will create opportunities for entrepreneurs, students, and inventors to formally and informally connect to a broader community through events, exchange engagements and news of entrepreneurial interest at the city, state, national and global level.
- **Capital**  
EnterpriseWorks Chicago cultivates funding sources and builds relationships within the capital community to improve opportunities and access to capital along the commercialization continuum.

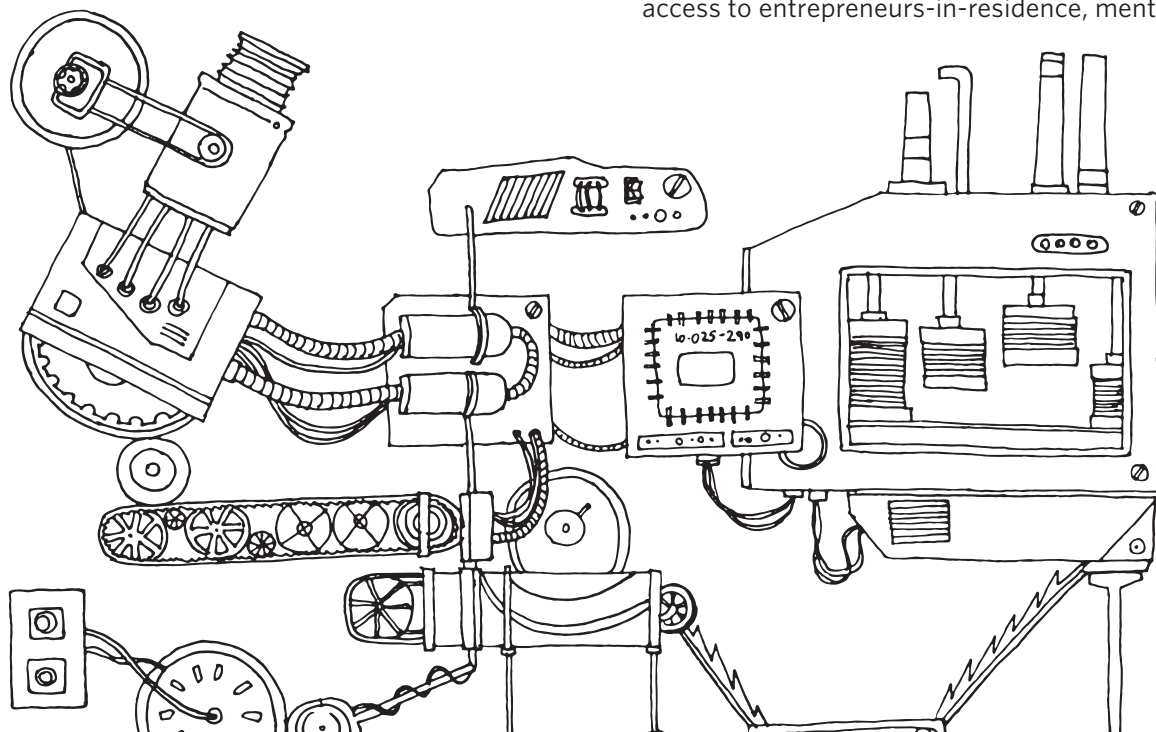

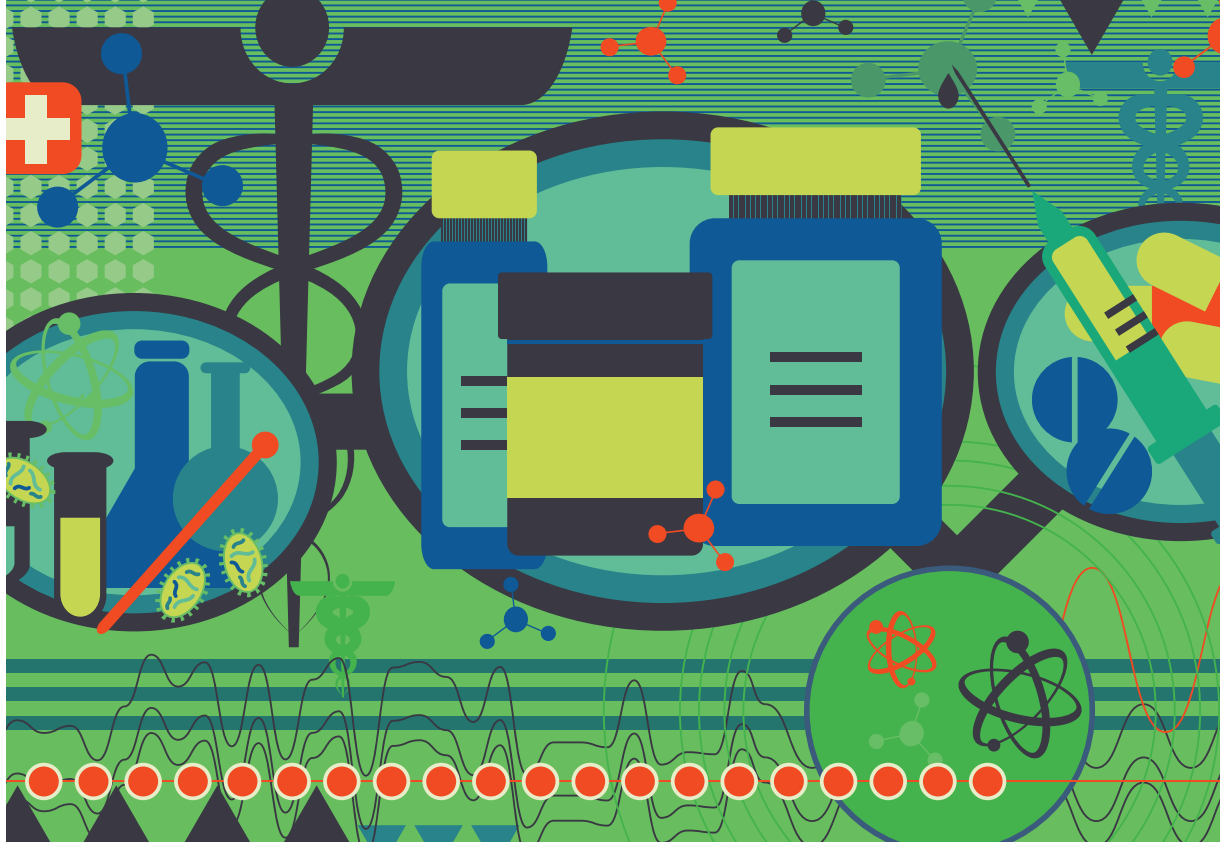

## HEALTH, TECHNOLOGY, INNOVATION (HTI)

As EnterpriseWorks Chicago's flagship program, HTI brings scientists, clinicians, engineers, and industry together for an interdisciplinary approach to drug, diagnostic, device, and information technology development. With the support of the Department of Commerce and Economic Opportunity, and Governor Pat Quinn, we are establishing a proof-of concept facility to validate commercial viability of health care technologies.

Located in the Illinois Medical District near UIC's Medical School campus, the new facility will house both shared wet and dry laboratory space,

in addition to office space. It will be anchored by a fully equipped meeting and classroom space with high-definition video conferencing, recording, and streaming.

The facility will provide the infrastructure where technology development work can take place outside of academic labs, with support and access to professional services, talent, industry networks, and connections to capital sources.

HTI will serve faculty, staff and students, Chicago area research institutions, and the broader entrepreneurial community.

HTI was funded through matching investments from the Illinois Department of Commerce and Economic Opportunity, as well as the University of Illinois at Chicago.

# SBIR/STTR Program

The Small Business Innovation Research (SBIR) and Small Business Technology Transfer (STTR) programs provide qualified small businesses, including faculty start-ups, with opportunities to propose innovative projects that meet specific federal needs. These programs offer more than \$2 billion dollars annually to support the research and technology development of small businesses across the nation. Awards are based on small business qualifications, degree of innovation, technical merit, and future market potential.

## Standard Phase I Process

6 to 9 months

Solicitation Topics

Proposal Submission

Evaluation

Phase I Award

SBIR funds support research by businesses with or without academic partners. STTR funds are also awarded to businesses, but recipients must collaborate with a U.S. research institution. The SBIR/STTR programs are structured in three phases, the first two of which are supported by SBIR/STTR funds.

**Phase I.** The objective of Phase I is to determine the scientific or technical merit and feasibility of the proposed R/R&D efforts. The Phase I period concentrates on the R&D efforts that prove the scientific or technical feasibility of the approach or concept and that which are a prerequisite for further support in Phase II. SBIR Phase I awards are for periods of up to six months in amounts of up to \$150,000. STTR Phase I awards are for periods of up to twelve months in amounts of up to \$100,000.

**Phase II.** The objective of Phase II is to continue the research or R&D effort initiated in Phase I with approaches that appear sufficiently promising because of Phase I. SBIR Phase II awards are for periods of up to two years in amounts of up to \$1,000,000. STTR Phase II awards are for periods of up to two years in amounts of up to \$750,000.

**Phase III.** An objective of the SBIR/STTR program is to increase private sector commercialization of innovations derived from Federal R/R&D. During Phase III, the small business concern is to pursue commercialization with non-SBIR/STTR funds.

## Federal Agencies Participating in SBIR

Each year, 11 federal departments and agencies reserve a portion of their R&D funds for award to small business through the SBIR program. These agencies include:

- Department of Agriculture
- Department of Commerce
- Department of Defense
- Department of Education
- Department of Energy
- Department of Health and Human Services
- Department of Homeland Security
- Department of Transportation
- Environmental Protection Agency
- National Aeronautics and Space Administration
- National Science Foundation

**Q: May a portion of an SBIR award be used to pay for outside services or assistance from a university or other nonprofit research institution?**

**Yes.** In Phase I, up to one-third of the award can be used for outside assistance, and in Phase II, up to one-half of the award.

## Federal Agencies participating in STTR

Each year, five federal departments and agencies reserve a portion of their R&D funds for award to small business or nonprofit research institution partnerships. These agencies include:

- Department of Defense
- Department of Energy
- Department of Health and Human Services
- National Aeronautics and Space Administration
- National Science Foundation

### Q: What is the minimum percentage of research that can be conducted by the small firm and institution receiving an STTR award?

Small business must perform at least 40 percent of the work, and research institutions must perform at least 30 percent.

### Q: When are the proposal deadlines?

Information on solicitations and proposal deadlines can be found at <http://www.zyn.com/sbir/>.

## Both the SBIR and STTR programs have specific eligibility criteria for participation.

### Small must fulfill the following criteria to participate in the SBIR program:

American-owned and independently operated

For-profit

Principal researcher at least 51% employed by the business, not a full time faculty member

Company size limited to 500 employees

### Small businesses must fulfill the following criteria to participate in the STTR Program:

American-owned and independently operated

For-profit

Principal researcher need not be employed by small business

Company size limited to 500 employees

While there is no size limit for a nonprofit research institution, the nonprofit research institution must also meet certain eligibility criteria:

- Located in the U.S.
- Nonprofit college or university
- Domestic nonprofit research organization
- Federally funded R&D center

The agencies participating in the SBIR/STTR programs have differing requirements for program involvement, and it is very important to understand and comply with these individual requirements. Each agency publishes a proposal solicitation at least annually. These solicitations can be viewed on their individual websites accessible at <http://www.zyn.com/sbir/>.

# Student

## ENTREPRENEURSHIP

The University of Illinois encourages entrepreneurship among everyone on campus – including students. In fact, the University offers various programs, courses, competitions, mentoring opportunities, support programs, and many other resources geared especially towards student entrepreneurship.

Note: for more information on intellectual property created by students, see the earlier section on student ownership.

## Student Entrepreneur Programs

The **Student Start-up Initiative** by EnterpriseWorks provides student entrepreneurs with free space each semester. This space is assigned based on competitive proposals submitted by students.

The **Technology Entrepreneur Center (TEC)** is an interdisciplinary program in the College of Engineering on the Urbana campus that engages faculty, students, and alumni in the practice of entrepreneurship. The center provides students



### Business Plan Competitions

- **Cozad New Venture Competition:** One UIUC-enrolled student must be actively involved in the company to apply. annually to U.S. colleges and universities in support of technology innovation and entrepreneurship with a positive social impact.
- **Illinois Innovation Prizes:** awarded annually to students displaying outstanding innovation.
- **NCIIA Grants:** With support from The Lemelson Foundation, the NCIIA awards approximately 2 million dollars in grants
- **Concept2Venture:** This is an annual business plan competition that provides UIC students with an opportunity to pitch their business plans to potential investors and compete for awards exceeding \$10,000.

and faculty with the skills, resources, and experiences necessary to become successful innovators, entrepreneurs, and leaders who are prepared to tackle grand challenges and change the world.

#### TEC OFFERS:

- **Innovation LLC** was created as a partnership between University Housing and TEC, and is an entrepreneurial living-learning community at Illinois Street Residence Hall where students are provided with specialized resources and programming to further their entrepreneurial goals.
- **SocialFuse** is a recurring pitching and networking event that brings together students from a variety of majors and backgrounds and fuses them together through their skills, ideas, and entrepreneurial passion. The event begins with a round of short pitching and idea sharing presentations followed by informal networking.
- **The Patent Clinic** is a joint effort between the TEC and the College of Law in which selected participants from the Cozad New Venture Competition and the Lemelson-Illinois Student Prize entrants can compete to have their patent application drafted for them free of cost.
- **Silicon Valley Entrepreneurship Workshop** sends a select group of students to Silicon Valley during winter break for a five day technology workshop that includes visits to start-up and leading technology companies.

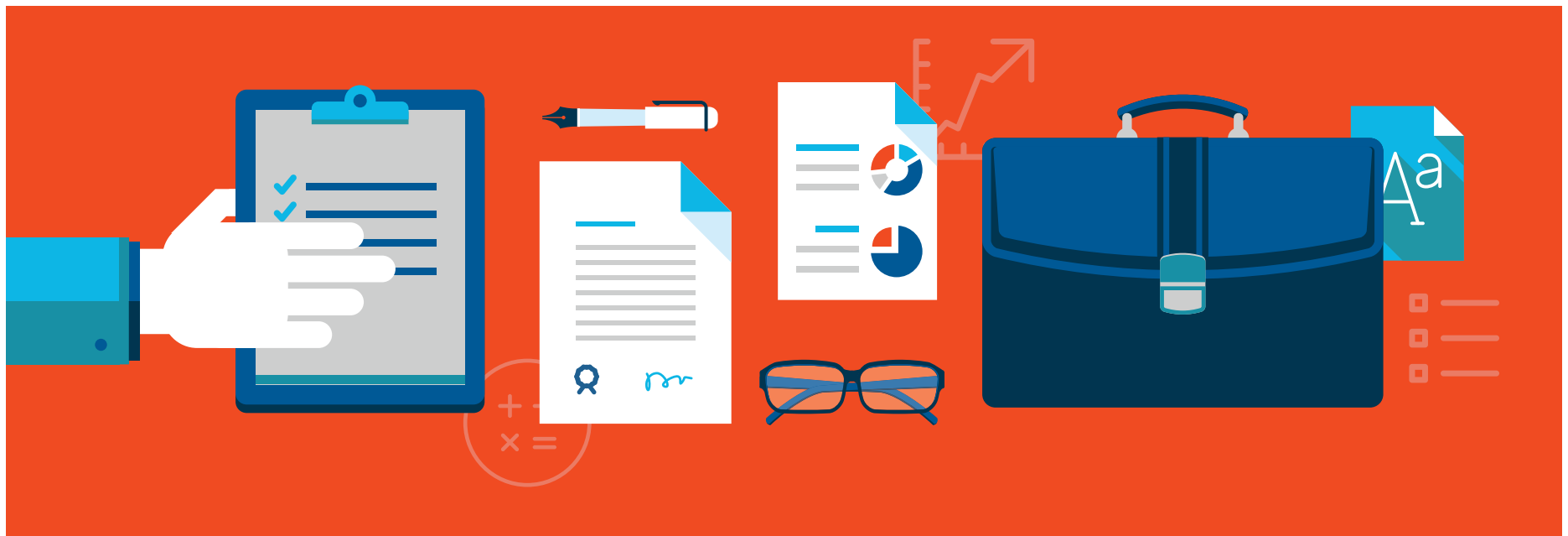



# Contacts

## CHICAGO

### **Office of Technology Management**

University of Illinois at Chicago  
1853 West Polk St., Suite 446, Chicago, IL 60612  
312.996.7018 ▪ [otm@uic.edu](mailto:otm@uic.edu)  
[otm.uic.edu](http://otm.uic.edu)

### **IllinoisVENTURES**

University of Illinois at Chicago  
312.251.0700  
[IllinoisVENTURES.com](http://IllinoisVENTURES.com)

### **EnterpriseWorks Chicago**

2201 West Campbell Park Drive, Chicago, IL 60612  
[ewchicago@illinois.edu](mailto:ewchicago@illinois.edu)  
[www.enterpriseworkschicago.com](http://www.enterpriseworkschicago.com)

### **Health, Technology, Innovation (HTI)**

2242 W. Harrison Street, Chicago IL 60612

## URBANA-CHAMPAIGN

### **Office of Technology Management**

University of Illinois at Urbana-Champaign  
Ceramics Building Suite 319  
105 S. Goodwin Ave., Urbana, IL 61802  
217.333.7862 ▪ [otm@illinois.edu](mailto:otm@illinois.edu)  
[otm.illinois.edu](http://otm.illinois.edu)

### **IllinoisVENTURES**

University of Illinois at Urbana-Champaign  
217.239.1950  
[IllinoisVENTURES.com](http://IllinoisVENTURES.com)

### **Research Park and EnterpriseWorks**

University of Illinois at Urbana-Champaign  
60 Hazelwood Drive, Champaign, IL 61820  
217.333.8324 ▪ [research-park@illinois.edu](mailto:research-park@illinois.edu)  
[researchpark.illinois.edu](http://researchpark.illinois.edu)

## OFFICE FOR THE VICE PRESIDENT OF RESEARCH

University of Illinois at Urbana-Champaign  
346 Henry Administration Building  
506 S. Wright St., Urbana, IL 61801  
217.265.5440 ▪ [vpr@uillinois.edu](mailto:vpr@uillinois.edu)  
[research.uillinois.edu](http://research.uillinois.edu)